

INNOVATION LEADS TO VALUE



SL12W WHEEL LOADER

◆ Rated power/speed:18.5kW/2200rpm ◆ Standard bucket capacity:0.38m³ ◆ Rated load capacity:1300kg



CONFIGURATION

Canopy

Electric Work Control

0.38 (Detachable Shovel Teeth)

Floating Function

Quick Hitch

Triple Mechanical Operation

Pressure Measuring Valve

OPTIONAL

Rops & Fops Cabin With Maintenance Port

Log Grasper

Goods Grasper

Cooling Air Conditioner (Optional With Cabin)

Heater

Cold Start Device

Radio

Mp3

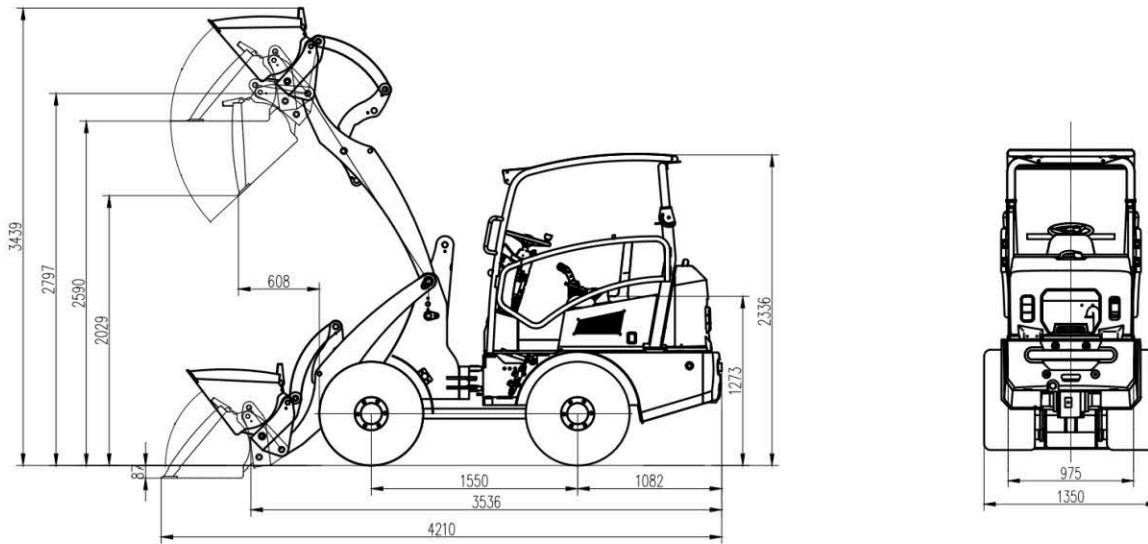

Vehicle parameters

Overall length (bucket on ground)	4210 mm
Overall Width	1350 mm
Overall Height	2336 mm
Bucket capacity	0.38 m ³
Rated load	1300 kg
Overall Weight	2500 kg
Max.Breakout Force	19 kN
Max.Tractive Force	17 kN
Max.Dumping height	2029 mm
Max.Dumping reach	608 mm
Min.base to the ground	240 mm
Wheelbase	1550 mm
WheelTread	975 mm
Tyre	10-16.5

Engine

Manufacturer/model	KUBOTA D1703 (Euro5/EPA4)
Rated Power	18.5 kw
Rated Speed	2200 r/min

Transmission System

Type	Hydrostatic
Shift gear control Type	Electric, Stepless
Travel speed	7/18

Bucket

Bucket width	1500 mm
Bucket type	Heavy-duty bolt on teeth

Operating System

Steering system	Full Hydraulic
Min.turning radius	3336 mm
Driving system	Hydrostatic driving, 4WD

Brake System

Service Brake	Drum brake
Parking Brake	drum brake

